



Datasheet

SC5319A/SC5320A

20 GHz to 40 GHz RF Downconverter

Rev 1.1

www.signalcore.com

Table of Contents

1. Definition of Terms	2
2. Description	3
3. Conversion Specifications.....	4
4. Amplitude Specifications.....	6
5. Dynamic Range Specifications	8
6. Internal LO Specifications.....	10
7. Port Specifications.....	12
8. General Specifications.....	13
9. Revision Table.....	15

1. Definition of Terms

The following terms are used throughout this datasheet to define specific conditions:

Specification (spec)	Defines expected statistical performance within specified parameters which account for measurement uncertainties and changes in performance due to environmental conditions. Protected by warranty.
Typical Data (typ)	Defines the expected performance of an average unit without specified parameters. Not protected by warranty.
Nominal Values (nom)	Defines the average performance of a representative value for a given parameter. Not protected by warranty.
Measured Values (meas.)	Defines the expected product performance from the measured results gained from individual samples.

Specifications are subject to change without notice. For the most recent product specifications, visit www.signalcore.com.

2. Description

The SC5319A/SC5320A is a Ka band broadband single stage downconverter, with input RF range from 20 GHz to 40 GHz, external LO frequency range from 10 GHz to 20 GHz, and output IF range from 100 MHz to 4.5 GHz. This module features an internal synthesized local oscillator, RF preamplifier, and variable gain control, making it a compact and versatile standalone downconverter module. With the option for an external LO signal, the SC5319A/SC5320A may be configured for SISO applications or paired together with multiple units for MIMO applications such as ground-based satellite communications, point-to-point radio, and test instrument systems.

The product also features a bypass path to route the rf signal directly to the next stage without conversion. The follow-on stage could be a lower frequency converter such as the SC5317A/SC5318A K-band downconverter, forming a 6 GHz to 40 GHz downconverter.

For systems requiring spectral selectivity, especially those used in open environments such as spectral monitoring, RF and IF bandpass filters may be placed before the RF input and after IF output ports respectively to suppress unwanted signals and improve out-of-band noise. An external IF filter will also provide further suppression of out-of-band internally generated spurious signals and LO leakages.

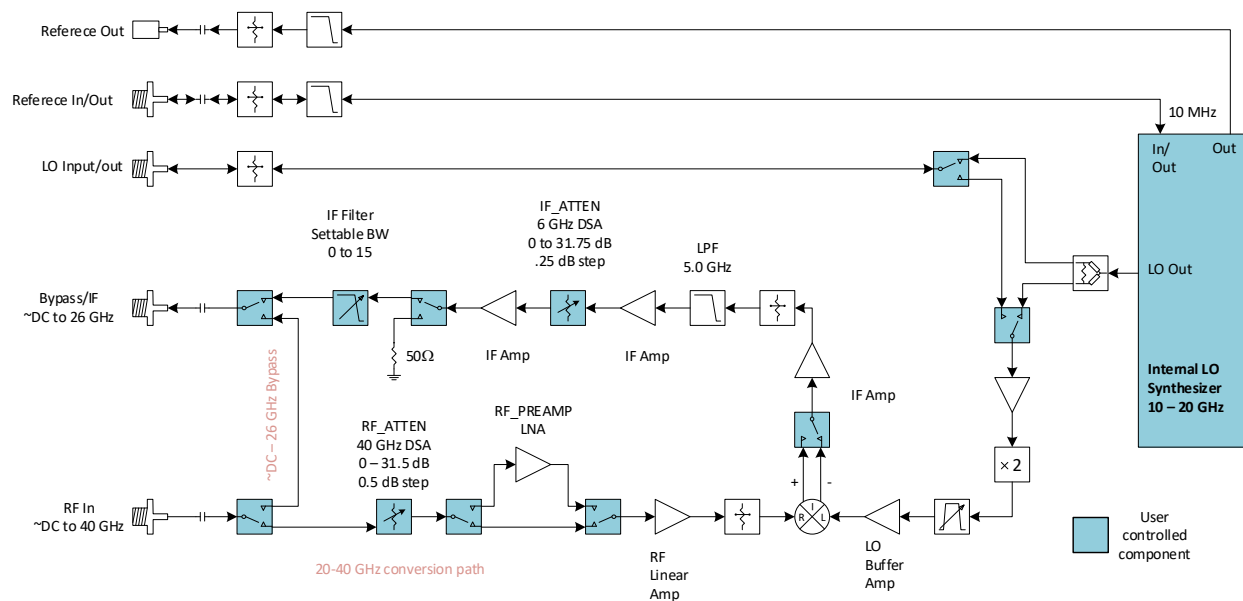

Figure 1. SC5319A/SC5320A Block Diagram

3. Conversion Specifications

RF Input Range		
Conversion Path	LO > RF @ 2G IF	19 GHz to (38 GHz – IF)
	LO < RF @ 2G IF	(20 GHz + IF) to 40 GHz
Direct Path		10 MHz to 26 GHz
External LO range		10 GHz to 20 GHz
IF output frequency ¹		100 MHz to 4500 MHz
IF output Polarity ²		Inverted
	LO > RF	Inverted
	LO < RF	Non-inverted
IF bandwidth (3 dB) ³		2000 MHz Typical

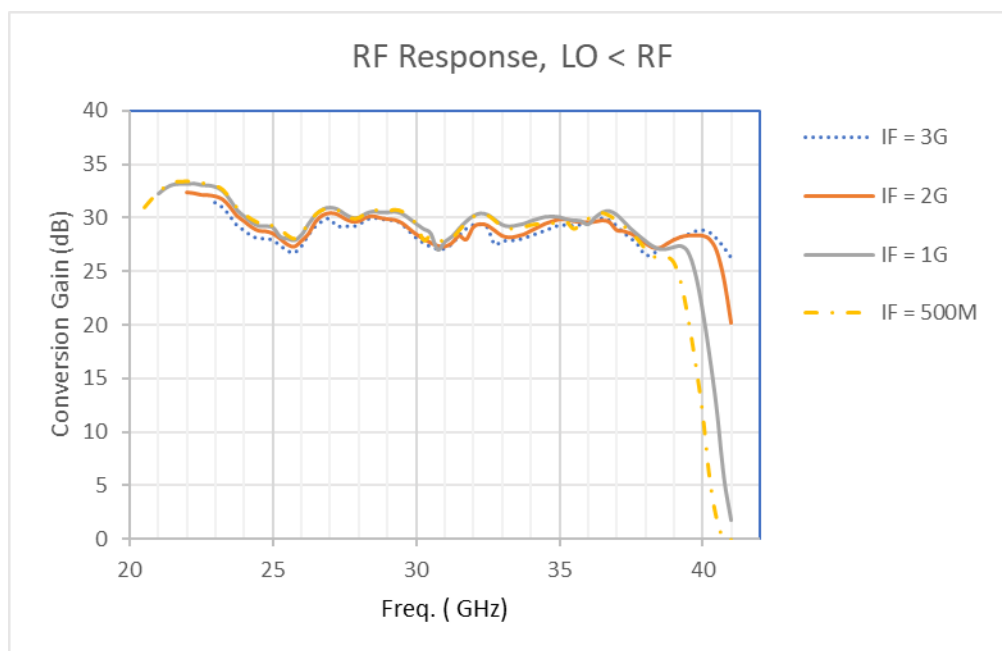

Figure 2. Measured conversion path RF response for different IF with RF > LO; If an external LO is used, the power is set at 5 dBm.

¹ IF output frequency is defined as the usable frequency range for all differences of $|LO - RF|$ and that LO and RF is limited to 20 to 38 GHz.

² The IF output polarity is inverted when the IF spectrum sense is in the opposite direction with respect to the input RF spectrum. This happens when the LO frequency is higher than the input RF.

³ The range of the IF bandwidth is determined by the boundaries of the spectrum whose amplitude varies less than 3 dB.

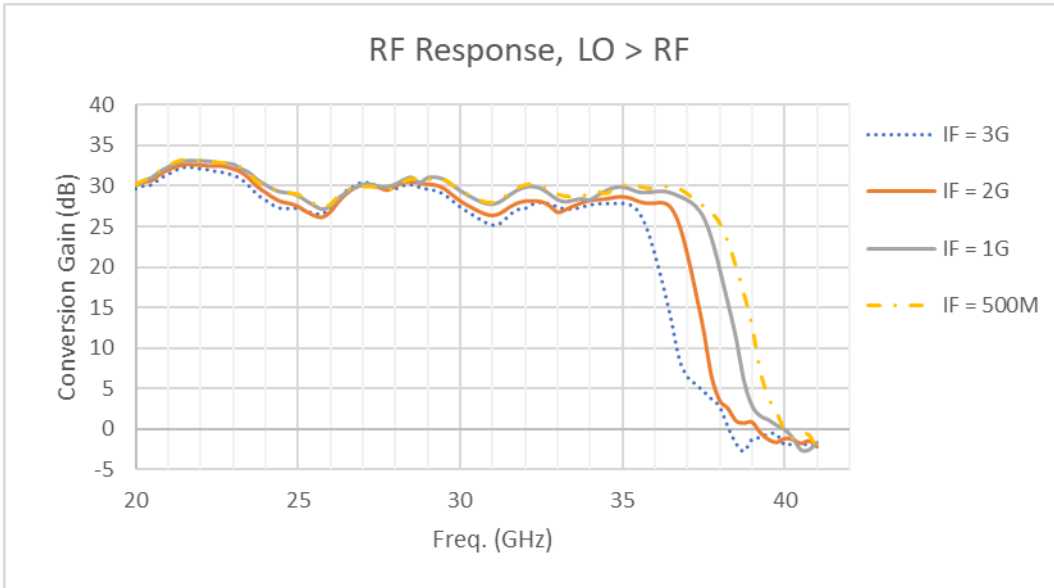

Figure 3. Measured conversion path RF response for different IF with LO > RF; If an external LO is used, the power is set at 5 dBm.

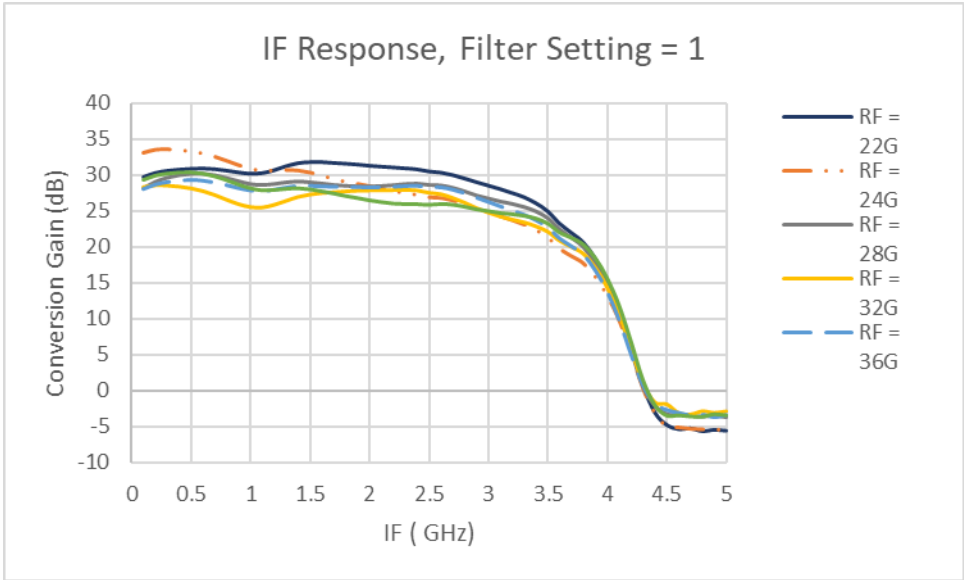

Figure 4. Measured IF response for different RF frequencies. LO < RF. If an external LO is used, set power to 5 dBm. IF filter setting = 1.

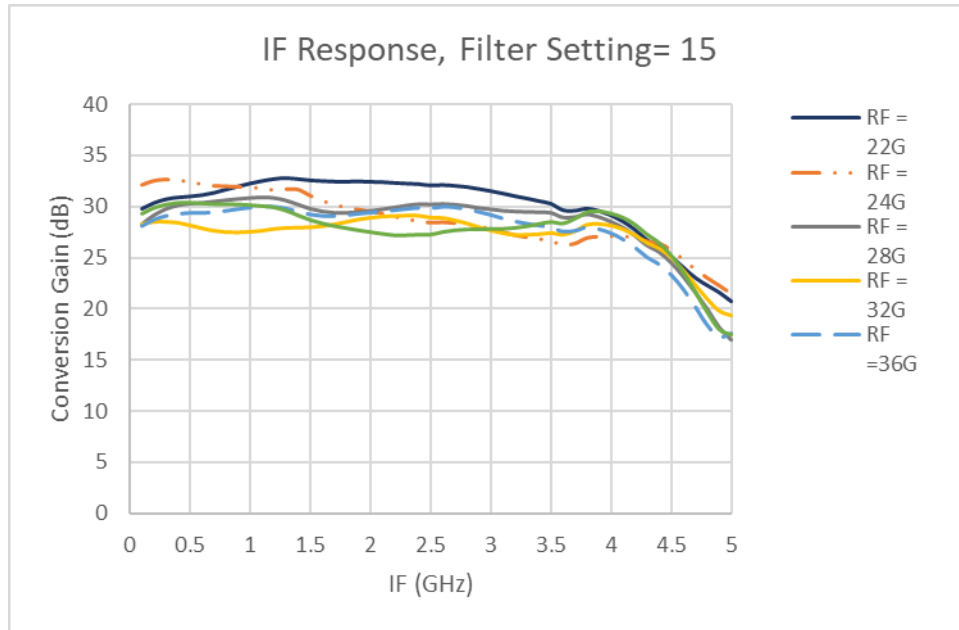

Figure 5. Measured IF response for different RF frequencies. LO < RF. If an external LO is used, set power to 5 dBm. If filter setting = 15.

4. Amplitude Specifications

Input Range	AC (preamplifier disabled)	+20 dBm max
	AC (preamplifier enabled)	+7 dBm max
	DC ⁴	0 V
Attenuation Range	RF	0 to 31 in 0.5 dB steps
	IF	0 to 31 in 0.5 dB steps
Input Voltage Standing Wave Ratio (VSWR)		
Preamp off, 0 dB input RF attenuation	20 GHz to 26 GHz	2.2
	26 GHz to 40 GHz	2.6
Preamp on, 0 dB input RF attenuation	20 GHz to 26 GHz	2.4
	26 GHz to 40 GHz	2.7

⁴ Large and fast DC transients could damage the input solid state devices. Slow ramp up of DC to 10 V is sustainable.

Gain Range	Minimum ⁵	-30 dB nom
	Maximum (preamplifier disabled) ⁶	30 dB nom
	Maximum (preamplifier enabled) ⁶	55 dB nom
Computed Gain Accuracy	Gain computed by API	± 2.5 dB
Preamplifier Gain		25 dB nom
Direct Path Loss		6 dB typical
RF Amplitude Response (25°C to 45°C device temperature)	RF Gain Flatness Response at Fixed IF	5 dB nom
IF Flatness (25°C to 45°C device temperature)	IF In-Band Response Flatness Over 3 GHz	3 dB typical

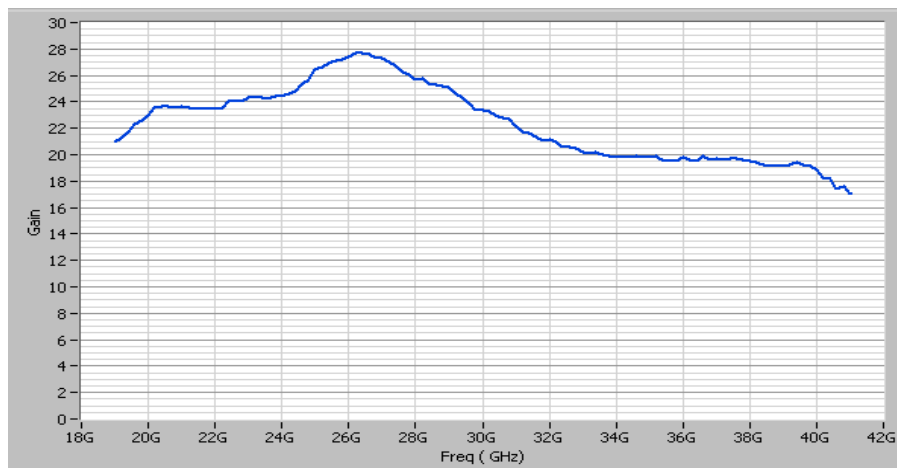

Figure 6. Nominal RF pre-amplifier response.

RF Port Local Oscillator Leakage	Preamplifier disabled, no RF attenuation	< -60 dBm typical
	Preamplifier enabled, no RF attenuation	< -75 dBm typical
IF Port Local Oscillator Leakage	IF enabled, no IF attenuation	< -60 dBm typical
	IF disabled, no IF attenuation	< -80 dBm typical

⁵ Minimal gain is specified when all attenuators, both RF and IF attenuators, are set to their maximum values and the RF pre-amplifier is disabled.

⁶ Maximum conversion gain is specified when all the attenuators are set to 0 dB attenuation.

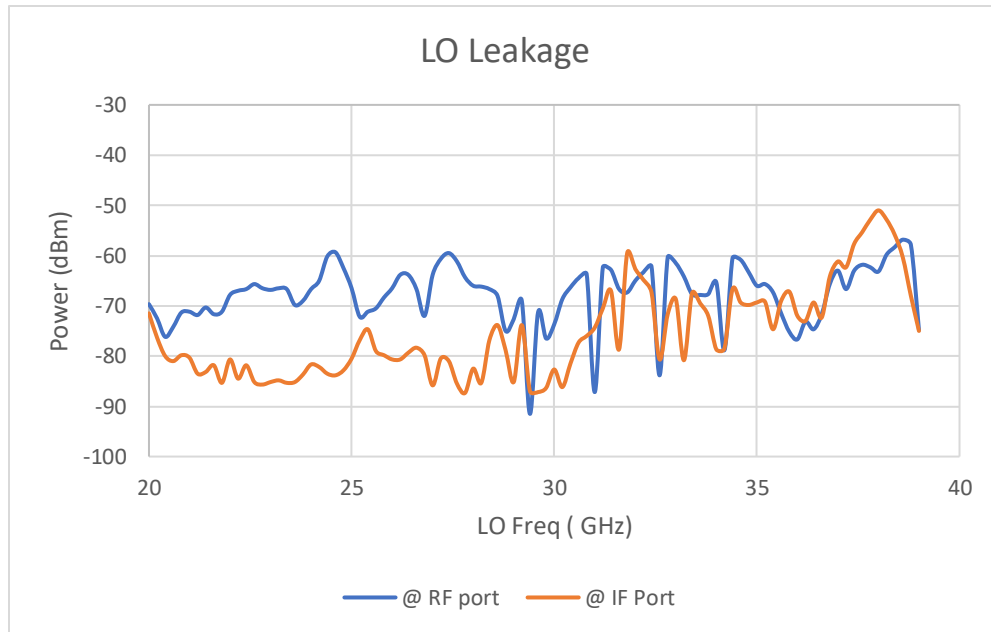

Figure 7. LO leakage measurement.

5. Dynamic Range Specifications

Spurious Response		
Residual Spurious Signals ⁷	RF < 29 GHz	< -70 dBm typ
	RF > 29 GHz	< -80 dBm typ
RF Induced Spurious Signals ⁸		< -60 dBc typ

⁷ Spurious signals at the IF port in the absence of RF input signals are due to internal LO associated signals.

⁸ Spurious signals at the IF port induced by the presence of a RF signal.

Input Noise Density (25°C to 40°C device temperature nominal)⁹

Preamplifier Disabled	22 GHz	30 GHz	38 GHz
Noise Floor (dBm/Hz)	-151	-149	-144
Noise Figure (dB)	23	25	30

Preamplifier Enabled	22 GHz	30 GHz	38 GHz
Noise Floor (dBm/Hz)	-161	-160	-158
Noise Figure (dB)	13	14	16

Input Third-Order Intermodulation (IIP3, dBm)

	20 GHz – 26 GHz	26 GHz – 34 GHz	34 GHz – 40 GHz
Preamplifier disabled	14	12	9
Preamplifier enabled	-8	-9	-10

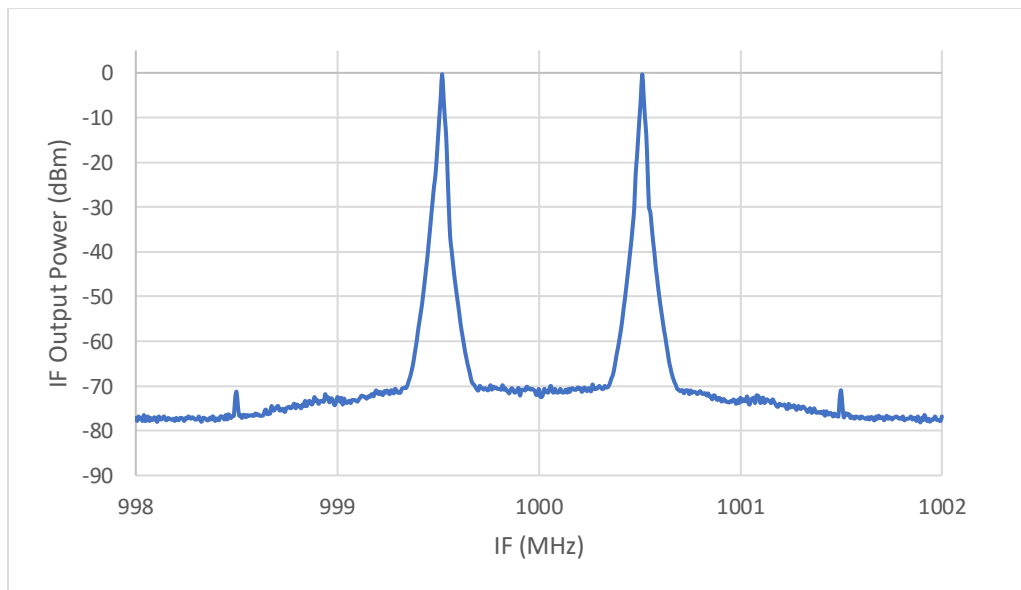

Figure 8. Plots show the typical IMD performance with two -20 dBm input signals centered at 26 GHz, LO at 25 GHz, 0 dB RF attenuation, preamp disabled, and IF attenuation set for gain equal to 20 dB.

⁹ Noise (thermal) density is referred to the input of the device.

Input Compression Point (dBm)

	19GHz – 22 GHz	22 GHz – 30 GHz	30 GHz – 40 GHz
Preamplifier disabled RF Atten = 0, Gain = 0	>6	>7	>8
Preamplifier enabled	-18	-15	-15

Output Compression Point (dBm)

	20 GHz – 36GHz	36.0 GHz – 40 GHz	
RF Atten = 0, IF Atten = 0	>17	>18	

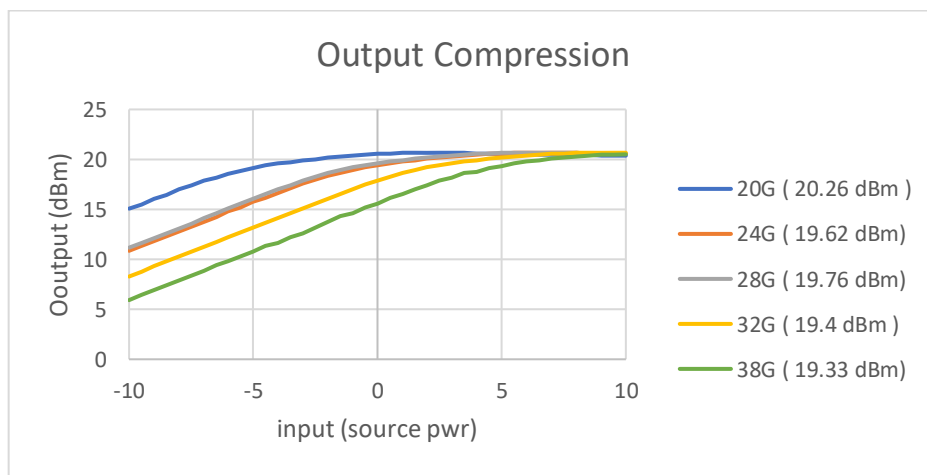

Figure 9. Output IF P1dB measurement: RF Atten = 0, IF Atten = 0

6. Internal LO Specifications

LO Frequency Range		1 0 GHz to 20 GHz
LO Tuning	Frequency Step Resolution	1 Hz
	Lock and Settling Times	1 ms typical
Output Power		0 dBm min, 7 dBm max

Frequency Reference¹⁰

Technology		OCXO
Accuracy		\pm [(aging x last adjustment time lapse) + temp stability + cal accuracy]
Initial Calibration Accuracy		\pm 20 ppb
Temperature Stability ¹¹	20°C to 50°C	\pm 25 ppb
	0°C to 80°C	\pm 50 ppb
Aging		\pm 30 ppb for first year

Frequency Accuracy

\pm (frequency reference accuracy in Hz * RF frequency) Hz

LO Phase Noise

Offset/LO	10 GHz		14 GHz		18 GHz		20 GHz	
	Typ	Max	Typ	Max	Typ	Max	Typ	Max
100 Hz	-78	-74	-75	-71	-73	-69	-72	-68
1 kHz	-105	-100	-103	-99	-100	-96	-99	-95
10 kHz	-115	-110	-113	-108	-111	-106	-110	-105
100 kHz	-116	-110	-113	-108	-112	-107	-110	-105
1 MHz	-115	-110	-114	-109	-112	-107	-110	105
10 MHz	-134	-132	-134	-132	-132	-129	-130	-127

¹⁰ The frequency reference refers to the device's internal 10 MHz OCXO time-base. Accuracy is in parts-per-billion, or ppb (1×10^{-9}).

¹¹ These are device temperatures as read back for its internal temperature sensor.

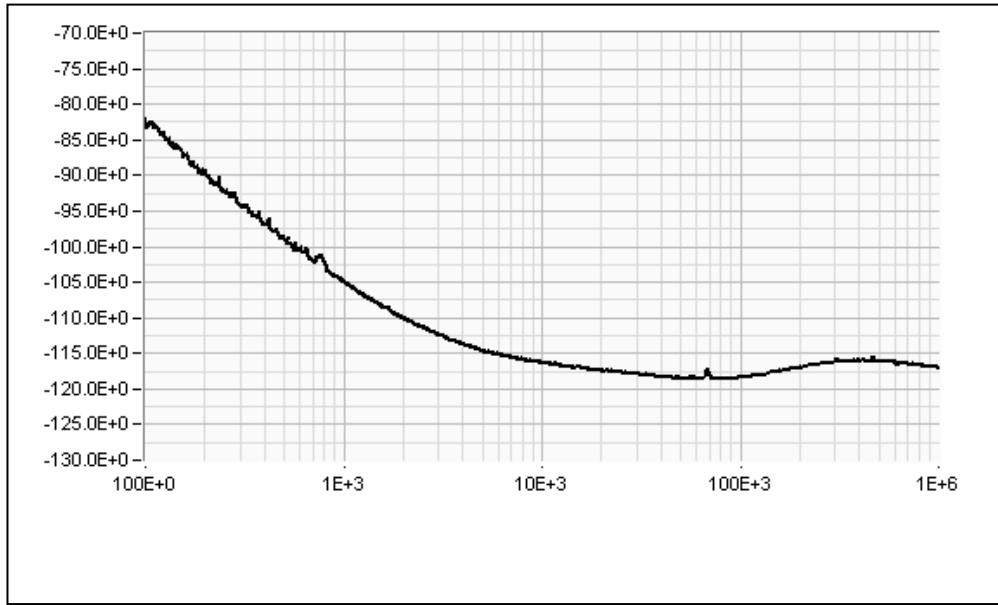

Figure 10. Typical measured LO sideband noise synth. Frequency @ 14 GHz

LO Related Sideband Spurious Signals	< 200 kHz	-55 dBc
	> 200 kHz	-60 dBc

7. Port Specifications

Reference Input/Out		
Reference	Reference Center Frequency	10 MHz
	Amplitude	Input: -3 dBm min / +10 dBm Output: 3 dBm typical
	Phase-Lock Range	± 3 ppm (typ)
	Impedance	50 Ω nominal
	Coupling	AC
	Connector Type	Input: SMA female Output: MMCX female

LO Input/LO Output

External LO input	Frequency Range	10 GHz to 20 GHz
	Input Amplitude	+3 dBm min / +7 dBm max

Synth LO output	Frequency Range	10 GHz to 20 GHz
	Output Amplitude	+0 dBm min / +7 dBm max

Impedance	50 Ω nominal
-----------	---------------------

Connector Type	SMA female
----------------	------------

Coupling	AC
----------	----

RF Input/Output

Input Impedance	50 Ω
-----------------	-------------

Coupling	AC
----------	----

Connector Type	Female 2.92
----------------	-------------

IF Output

Output Impedance	50 Ω
------------------	-------------

Coupling	AC
----------	----

Connector Type	SMA female
----------------	------------

8. General Specifications

Environmental

Device Operating Temperature	0°C to +75°C
------------------------------	--------------

Storage Temperature	-40°C to +85°C
---------------------	----------------

Operating Relative Humidity	10% to 90%, non-condensing
-----------------------------	----------------------------

Storage Relative Humidity	5% to 90%, non-condensing
---------------------------	---------------------------

Operating Shock	30 g, half-sine pulse, 11 ms duration
-----------------	---------------------------------------

Storage Shock	50 g, half-sine pulse, 11 ms duration
---------------	---------------------------------------

Operating Vibration	5 Hz to 500 Hz, 0.31 g _{rms}
---------------------	---------------------------------------

Storage Vibration	5 Hz to 500 Hz, 2.46 g _{rms}
-------------------	---------------------------------------

Altitude	2,000 m maximum (maintain 25°C maximum ambient temperature)
----------	-------------------------------------------------------------

Physical

Dimensions (W x H x D, max envelope)	SC5320A	3.7" x 0.75" x 6.1"
--------------------------------------	---------	---------------------

	SC5319A PXIe	1 slot
--	--------------	--------

Weight		1.0 lb.
--------	--	---------

Input Voltage		12 VDC
---------------	--	--------

Power Consumption	Internal LO Disabled	12 W max
-------------------	----------------------	----------

	Internal LO Enabled	25 W max
--	---------------------	----------

Communication Interface		PXIe, USB and RS-232 / SPI
-------------------------	--	----------------------------

EMC and Product Safety	Designed to meet the requirements of:	2014/30/EU: EN 61326-1:2013 EN 55011:2009 2014/35/EU: EN 61010-1
Warranty		3 years parts and labor on defects in materials or workmanship

9. Revision Table

Revision	Revision Date	Description
0.1	July 19, 2021	Preliminary
0.2	Nov 23, 2021	Corrected bypass loss
1.0	Apr 12, 2022	Updated graphs and corrected grammar
1.1	July 10, 2023	i) Placed Max limit on phase noise of local oscillator. ii) Corrected frequency range of bypass path.

